

## Low $V_F$ Single-Phase Single In-Line Bridge Rectifiers

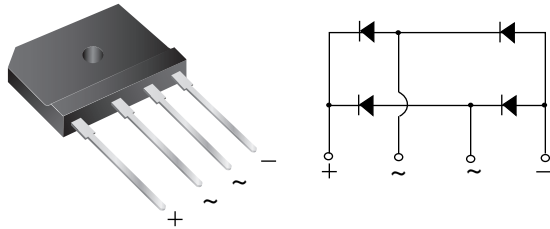

Case Style GSIB-5S

PRIMARY CHARACTERISTICS	
$I_{F(AV)}$	15 A
$V_{RRM}$	600 V
$I_{FSM}$	400 A
$I_R$	10 $\mu$ A
$V_F$ at $I_F = 7.5$ A, $T_A = 125$ °C	0.73 V
$T_J$ max.	150 °C

### FEATURES

- UL recognition file number E54214, Vol. 1
- Thin single in-line package
- Oxide planar chip junction
- Low forward voltage drop
- High surge current capability
- High case dielectric strength of 2500  $V_{RMS}$
- Solder dip 275 °C max. 10 s, per JESD 22-B106
- Compliant to RoHS Directive 2002/95/EC and in accordance to WEEE 2002/96/EC
- Halogen-free according to IEC 61249-2-21 definition



RoHS  
COMPLIANT  
HALOGEN  
FREE

### TYPICAL APPLICATIONS

General purpose use in AC/DC bridge full wave rectification for switching power supply, home appliances and white-goods applications specially for Telecom power supply, high efficiency desktop PC and server SMPS:

### MECHANICAL DATA

**Case:** GSIB-5S

Epoxy meets UL 94 V-0 flammability rating

Base P/N-M3 - halogen-free, RoHS compliant, and commercial grade

**Terminals:** Matte tin plated leads, solderable per J-STD-002 and JESD 22-B102

M3 suffix meets JESD 201 class 1A whisker test

**Polarity:** As marked on body

**Mounting Torque:** 10 cm-kg (8.8 in-lbs) maximum

**Recommended Torque:** 5.7 cm-kg (5 in-lbs)

MAXIMUM RATINGS ( $T_A = 25$ °C unless otherwise noted)			
PARAMETER	SYMBOL	LVB1560	UNIT
Maximum repetitive peak reverse voltage	$V_{RRM}$	600	V
Maximum average forward rectified output current at	$T_C = 125$ °C	$I_O^{(1)}$	15
	$T_A = 25$ °C	$I_O^{(2)}$	3.6
Non-repetitive peak forward surge current 8.3 ms single sine-wave, $T_J = 25$ °C	$I_{FSM}$	400	A
Rating for fusing ( $t < 8.3$ ms)	$T_J = 25$ °C	$I^2t$	664
Operating junction and storage temperature range	$T_J, T_{STG}$	- 55 to + 150	°C

#### Notes

(1) Unit case mounted on aluminum plate heatsink

(2) Units mounted on PCB without heatsink

ELECTRICAL CHARACTERISTICS (T <sub>A</sub> = 25 °C unless otherwise noted)						
PARAMETER	TEST CONDITIONS		SYMBOL	TYP.	MAX.	UNIT
Instantaneous forward voltage	I <sub>F</sub> = 7.5 A	T <sub>A</sub> = 25 °C	V <sub>F</sub> <sup>(1)</sup>	0.87	0.90	V
		T <sub>A</sub> = 125 °C		0.73	-	
Reverse current per diode	V <sub>R</sub> = 600 V	T <sub>A</sub> = 25 °C	I <sub>R</sub> <sup>(2)</sup>	0.2	10	μA
		T <sub>A</sub> = 125 °C		60	-	
Typical reverse recovery time	I <sub>F</sub> = 0.5 A, I <sub>R</sub> = 1.0 A, I <sub>rr</sub> = 0.25 A		t <sub>rr</sub>	1.8	-	μs
Typical junction capacitance	4.0 V, 1 MHz		C <sub>J</sub>	260	-	pF

**Notes**

- (1) Pulse test: 300 μs pulse width, 1 % duty cycle
- (2) Pulse test: pulse width ≤ 40 ms

THERMAL CHARACTERISTICS (T <sub>A</sub> = 25 °C unless otherwise noted)			
PARAMETER	SYMBOL	LVB1560	UNIT
Maximum thermal resistance	R <sub>θJA</sub> <sup>(2)</sup>	25	°C/W
	R <sub>θJC</sub> <sup>(1)</sup>	1.0	

**Notes**

- (1) With heatsink
- (2) Without heatsink, free air

EMC SURGE IMMUNITY TEST STANDARD (T <sub>A</sub> = 25 °C, unless otherwise noted)					
STANDARD	TEST TYPE	TEST CONDITIONS	SYMBOL	CLASS	VALUE
IEC 61000-4-5	Power supply coupling mode, line to line	1.2/50 μs waveform, R = 2 Ω, T <sub>A</sub> = 25 °C <sup>(1)</sup>	V <sub>PEAK</sub>	-	6 kV maximum

**Note**

- (1) Immunity to IEC 61000-4-5 peak pulse voltage test, 1.2/50 μs, 2 Ω, 5 times each of positive and negative polarity test

ORDERING INFORMATION (Example)				
PREFERRED P/N	UNIT WEIGHT (g)	PREFERRED PACKAGE CODE	BASE QUANTITY	DELIVERY MODE
LVB1560-M3/45	6.9	45	20	Tube

**RATINGS AND CHARACTERISTICS CURVES**

(T<sub>A</sub> = 25 °C unless otherwise noted)

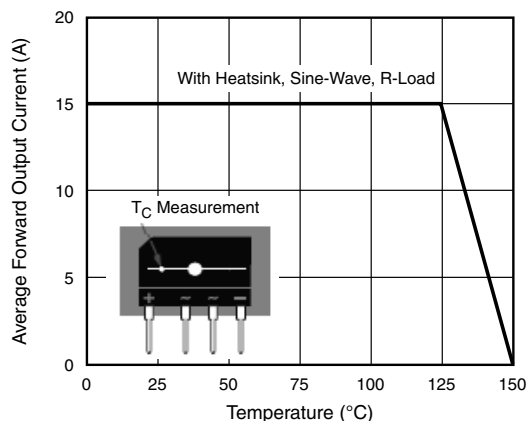

Fig. 1 - Derating Curve Output Rectified Current

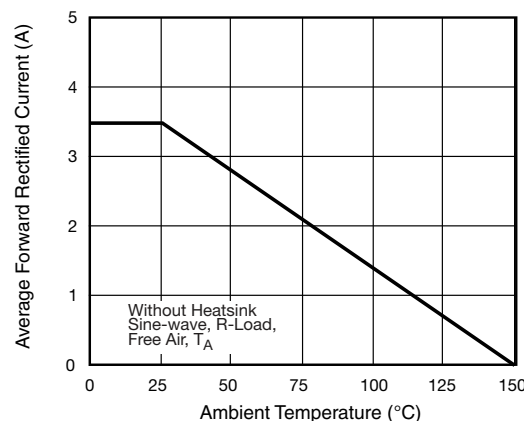

Fig. 2 - Forward Current Derating Curve

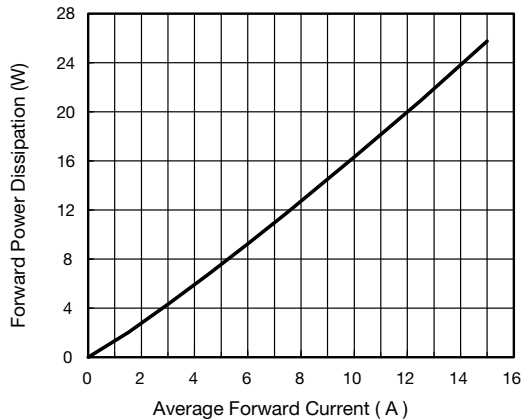

Fig. 3 - Forward Power Dissipation

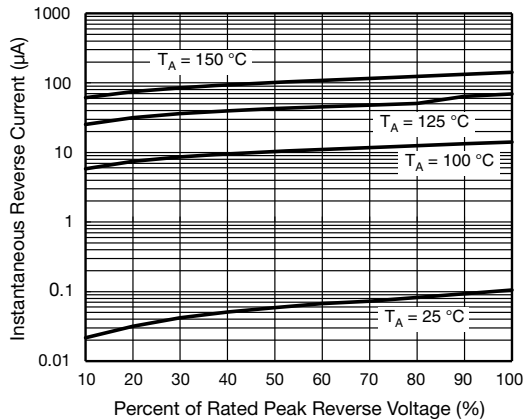

Fig. 5 - Typical Reverse Characteristics Per Diode

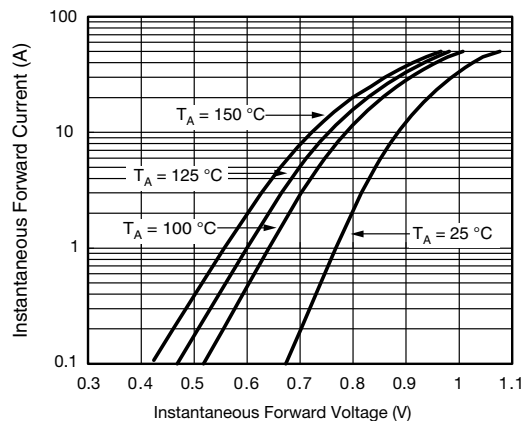

Fig. 4 - Typical Forward Characteristics Per Diode

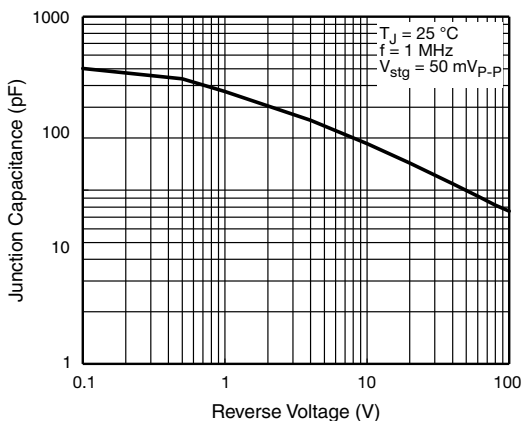
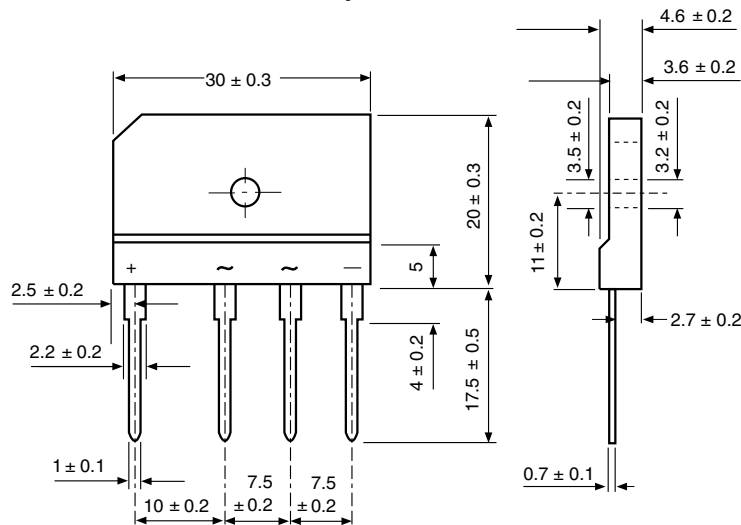

Fig. 6 - Typical Junction Capacitance Per Diode

**PACKAGE OUTLINE DIMENSIONS** in millimeters

**Case Style GSIB-5S**





## Disclaimer

ALL PRODUCT, PRODUCT SPECIFICATIONS AND DATA ARE SUBJECT TO CHANGE WITHOUT NOTICE TO IMPROVE RELIABILITY, FUNCTION OR DESIGN OR OTHERWISE.

Vishay Intertechnology, Inc., its affiliates, agents, and employees, and all persons acting on its or their behalf (collectively, "Vishay"), disclaim any and all liability for any errors, inaccuracies or incompleteness contained in any datasheet or in any other disclosure relating to any product.

Vishay makes no warranty, representation or guarantee regarding the suitability of the products for any particular purpose or the continuing production of any product. To the maximum extent permitted by applicable law, Vishay disclaims (i) any and all liability arising out of the application or use of any product, (ii) any and all liability, including without limitation special, consequential or incidental damages, and (iii) any and all implied warranties, including warranties of fitness for particular purpose, non-infringement and merchantability.

Statements regarding the suitability of products for certain types of applications are based on Vishay's knowledge of typical requirements that are often placed on Vishay products in generic applications. Such statements are not binding statements about the suitability of products for a particular application. It is the customer's responsibility to validate that a particular product with the properties described in the product specification is suitable for use in a particular application. Parameters provided in datasheets and/or specifications may vary in different applications and performance may vary over time. All operating parameters, including typical parameters, must be validated for each customer application by the customer's technical experts. Product specifications do not expand or otherwise modify Vishay's terms and conditions of purchase, including but not limited to the warranty expressed therein.

Except as expressly indicated in writing, Vishay products are not designed for use in medical, life-saving, or life-sustaining applications or for any other application in which the failure of the Vishay product could result in personal injury or death. Customers using or selling Vishay products not expressly indicated for use in such applications do so at their own risk and agree to fully indemnify and hold Vishay and its distributors harmless from and against any and all claims, liabilities, expenses and damages arising or resulting in connection with such use or sale, including attorneys fees, even if such claim alleges that Vishay or its distributor was negligent regarding the design or manufacture of the part. Please contact authorized Vishay personnel to obtain written terms and conditions regarding products designed for such applications.

No license, express or implied, by estoppel or otherwise, to any intellectual property rights is granted by this document or by any conduct of Vishay. Product names and markings noted herein may be trademarks of their respective owners.